



TS1000 Pro Series

TS1000 Pro Tripod Turnstile

TS1011Pro Tripod Turnstile

(w/ controller and RFID reader)

TS1022 Pro Tripod Turnstile

(w/ controller and combination fingerprint & RFID reader)

The ZKTeco TS1000 Pro tripod turnstile series is a compact and cost-effective entrance control system designed for high-traffic volume.

TS1000 Pro is a single-lane tripod turnstile series designed for smooth and silent operation and draws very little power. It's made of stainless steel which makes TS1000 Pro highly durable. TS1000 Pro is also surprisingly compact and designed to operate in small workspaces.

TS1000 Pro tripod arms are normally held in a locked position, thus denying access to the secured side. Upon TS1000 Pro's reader (RFID and/or fingerprint) positively recognizing a user's valid access card or fingerprint, its tripod arms unlock, thus allowing users passage to the secured side.

During emergencies and power outages the tripod arms completely collapse, thereby ensuring users FAST unencumbered exit to safety.

TS1000 Pro provides both security and convenience, all in a very durable compact design.

Features

Reliability

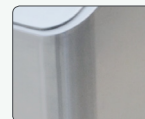

- Alloy steel tripod hub and SUS304 stainless steel casework & tripod arms ensure long-lasting durability
- Power conservation. Electro-magnetic locks remain in "standby mode" until turnstile is activated
- Patented oil lubrication system reduces need for maintenance
- High quality electrical components



Safety Features

- Tripod-arms unlock & drop during emergencies /power loss
- Visual indicator for access granted (or denied)
- Ergonomic design makes card and fingerprint authentication fast & simple for users
- Secure. Supports Anti-tailgating



Built-in Reader Integration



- TS1000 Pro series ships already integrated with our customers' preference for either card or fingerprint access control reader. This greatly reduces installation time & expense
- TS1000 Pro series and associated access control readers are all factory-tested prior to shipping

Specifications

Power requirements		AC110V/220V, 50/60Hz
Power consumption	Starting	68W
	Standby	15W
	Unlock	60W
Working temperature		-28 °C - 60 °C
Working humidity		5%-80%
Working environment		Indoor/Outdoor(if sheltered)
Speed of throughput	RFID	Maximum 30/minute
	Fingerprint	Maximum 25/minute
Lane width(mm)		500
Footprint(mm*mm)		520*810
Dimension(mm)		L=520, W=310, H=1010
Dimension with packing(mm)		L=570, W=365, H=1080
Net weight(kg)		34
Weight with packing(kg)		40
LED indicator		Y
Cabinet material		SUS304 Stainless Steel
Lid material		SUS304 Stainless Steel
Barrier material		SUS304 Stainless Steel
Barrier movement		Rotating
Emergency mode		Y
Security level		Medium
MCBF		1 million
Options/Accessories		Counter, SUS316 Cabinet and Lid, Remote Control

Dimensions (mm)

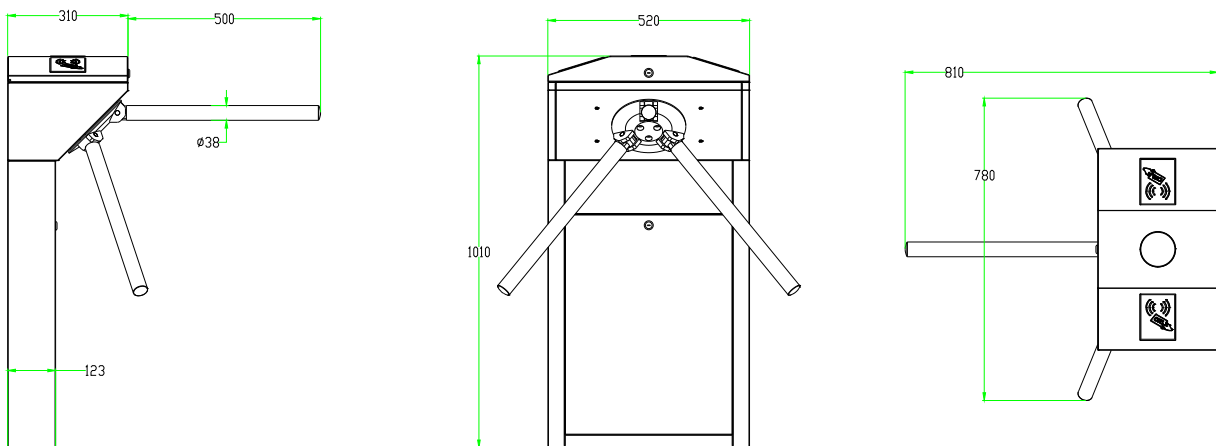

ZKTECO CO.,LTD.
 www.zkteco.com
 E-mail: sales@zkteco.com

© Copyright 2018. ZKTECO CO., LTD. ZKTECO Logo is a registered trademark of ZKTECO CO., LTD. or a related company. All other products and company names mentioned are used for identification purposes only and may be the trademarks of their respective owners. All specifications are subject to change without notice. All rights reserved.

